

Article number: 20516ND5736M6

Description: E+G Magnet - female thread GN 51.6-ND-57-36-M6  
Neodym, jern, bor - 80° C, 175N

## Measures

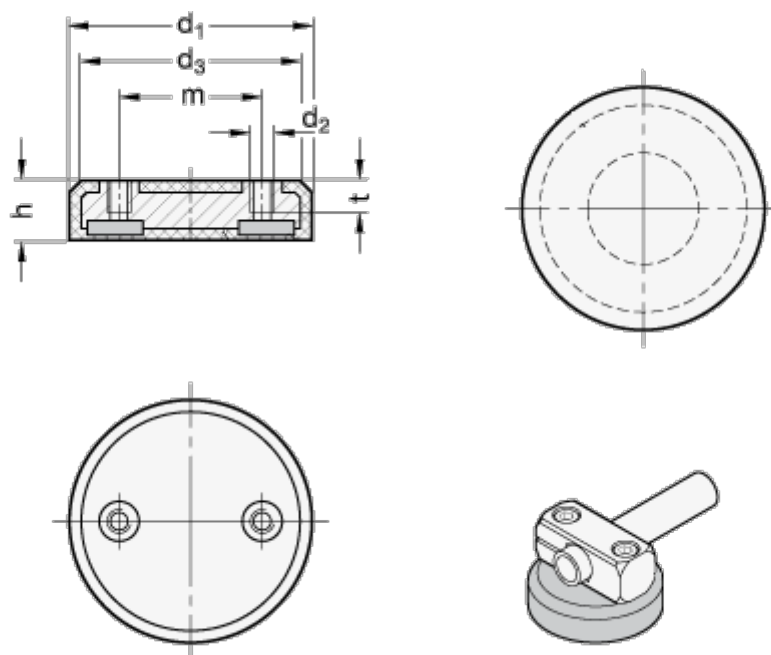

d1	= 57
d2	= M6
d3	= 53
h	= 11.3
Holding force N	= 175
m	= 36
t	= 7